

4 Watt Ka Band Packaged Amplifier

TGA4905-CP



Key Features and Performance

- 36 dBm VSAT band Psat
- 22 dB Nominal Gain
- 25 - 31 GHz Frequency Range
- 0.25µm pHEMT Technology
- Bias Conditions: 6 V, 2.1 A (Quiescent)
up to 4 A under RF drive
- Package Dimensions:
13.34 x 9.65 x 1.85 mm
(0.525 x 0.380 x 0.073 in)

Product Description

The TriQuint TGA4905-CP is a compact 4 Watt High Power Amplifier Packaged MMIC for Ka-band applications. The part is designed using TriQuint's proven standard 0.25 um gate Power pHEMT production process.

The TGA4905 provides a nominal 36 dBm of output power at an input power level of 18 dBm from 25-31 GHz with a small signal gain of 22 dB.

The part is ideally suited for low cost emerging markets such as base station transmitters for satellite ground terminals, point to point radio and LMDS.

The TGA4905-CP is 100% RF tested to ensure performance compliance.

Primary Applications

- Satellite Ground Terminals
- Point to Point

Measured Performance

Bias Conditions: Vd=6 V Idq=2.1 A

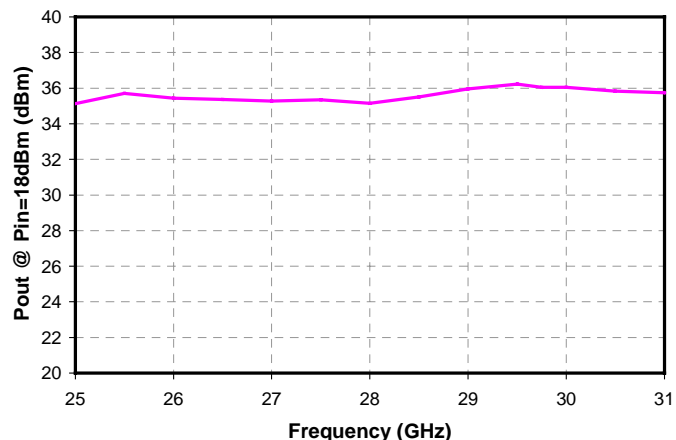
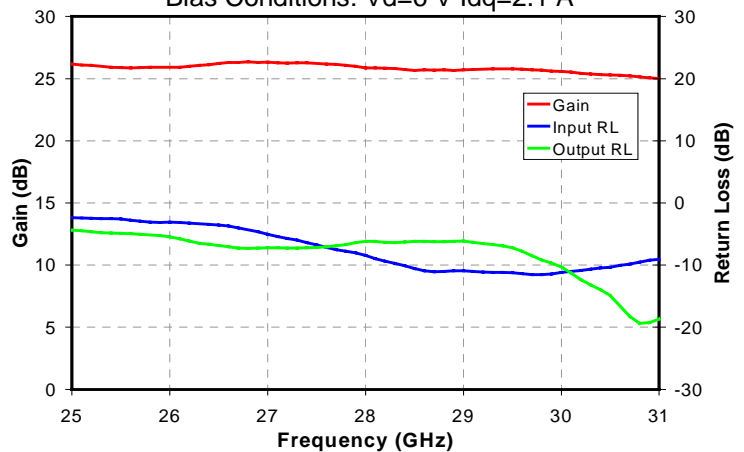

Note: This device is early in the characterization process prior to finalizing all electrical specifications. Specifications are subject to change without notice.

**TABLE I
MAXIMUM RATINGS**

Symbol	Parameter <u>1/</u>	Value	Notes
V_D	Drain Voltage	8 V	<u>2/</u>
V_G	Gate Voltage Range	-5 V to 0 V	
I_D	Drain Current (Quiescent)	3.0 A	<u>2/</u>
$ I_G $	Gate Current	62 mA	
P_{IN}	Input Continuous Wave Power	24 dBm	<u>2/</u>
P_D	Power Dissipation	16.8 W	<u>2/ 3/</u>
T_{CH}	Operating Channel Temperature	150 °C	<u>4/ 5/</u>
T_M	Mounting Temperature (30 Seconds)	320 °C	
T_{STG}	Storage Temperature	-65 to 150 °C	

- 1/ These ratings represent the maximum operable values for this device.
- 2/ Combinations of supply voltage, supply current, input power, and output power shall not exceed P_D .
- 3/ P_D is the power dissipation allowed in order to reach a channel temperature of 150°C with a package base temperature of 70°C. When operated at this power dissipation with a baseplate temperature of 70°C, the MTTF is 1.0E+6 hours.
- 4/ These ratings apply to each individual FET.
- 5/ Junction operating temperature will directly affect the device median time to failure (T_M). For maximum life, it is recommended that junction temperatures be maintained at the lowest possible levels.

TABLE II
RF CHARACTERIZATION TABLE
($T_A = 25^\circ\text{C}$, Nominal)
($V_D = 6\text{ V}$, $I_{DQ} = 2.1\text{ A}$)

SYMBOL	PARAMETER	TEST CONDITION	TYPICAL	UNITS
Gain	Small Signal Gain	$F = 25 - 31\text{GHz}$	22	dB
IRL	Input Return Loss	$F = 25 - 31\text{GHz}$	10	dB
ORL	Output Return Loss	$F = 25 - 31\text{GHz}$	8	dB
PWR	Output Power @ Psat	$F = 25 - 31\text{GHz}$	36	dBm

TABLE III
THERMAL INFORMATION

Parameter	Test Conditions	T_{CH} ($^\circ\text{C}$)	$R_{\theta JC}$ ($^\circ\text{C/W}$)	T_M (hrs)
$R_{\theta JC}$ Thermal Resistance (Channel to Backside of Package)	$V_D = 6\text{ V}$ $I_D = 2.1\text{ A}$ (Quiescent) $P_{DISS} = 12.6\text{ W}$	128.35	4.63	6.9 E+6

Note: Backside of package is at 70°C baseplate temperature. Worst case is at saturated output power when DC power consumption rises to 23 W with 4 W RF power delivered to load. Power dissipated is 19 W and the temperature rise in the channel is 88°C . Baseplate temperature must be reduced to 62°C to remain below the 150°C maximum channel temperature.

Measured Fixtured Performance

$V_D = 6\text{ V}$ $I_{dq} = 2.1\text{ A}$

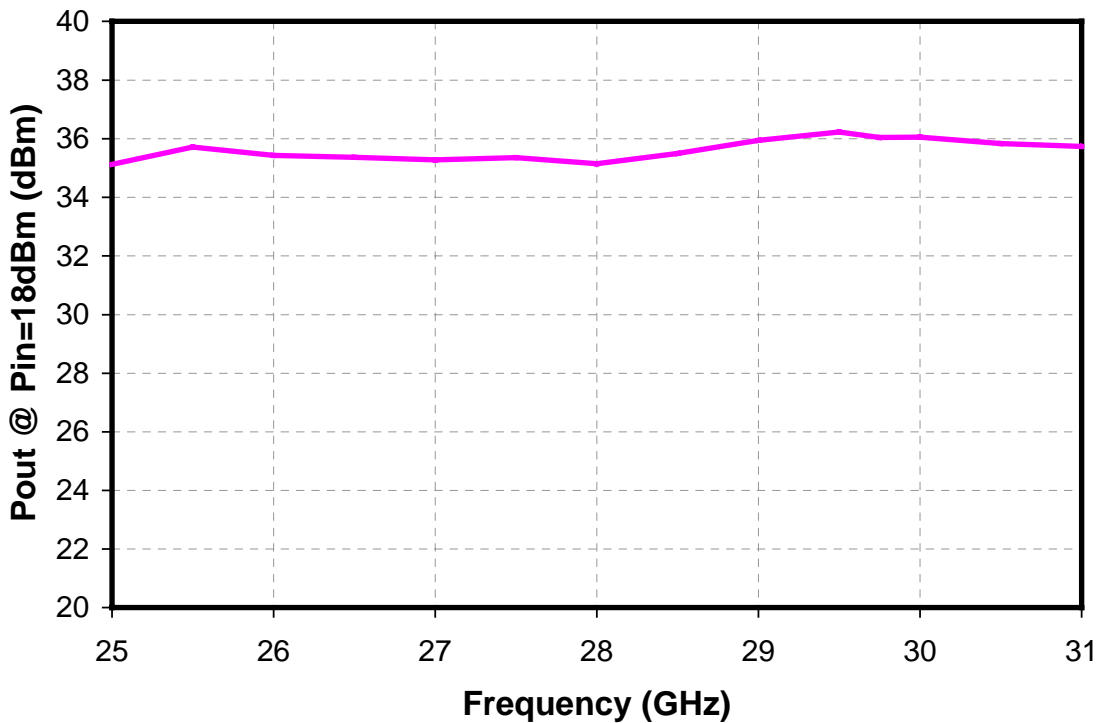
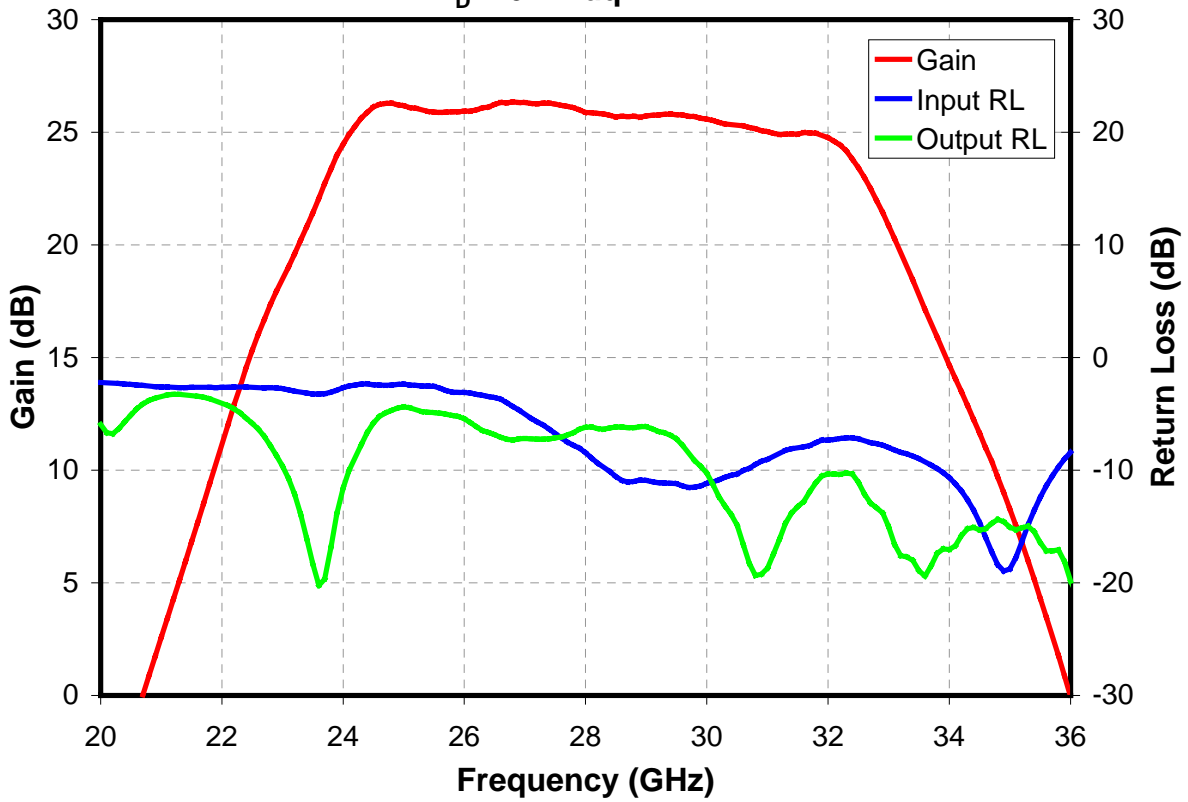

Measured Fixtured Performance

$V_D = 6\text{ V}$ $I_{dq} = 2.1\text{ A}$

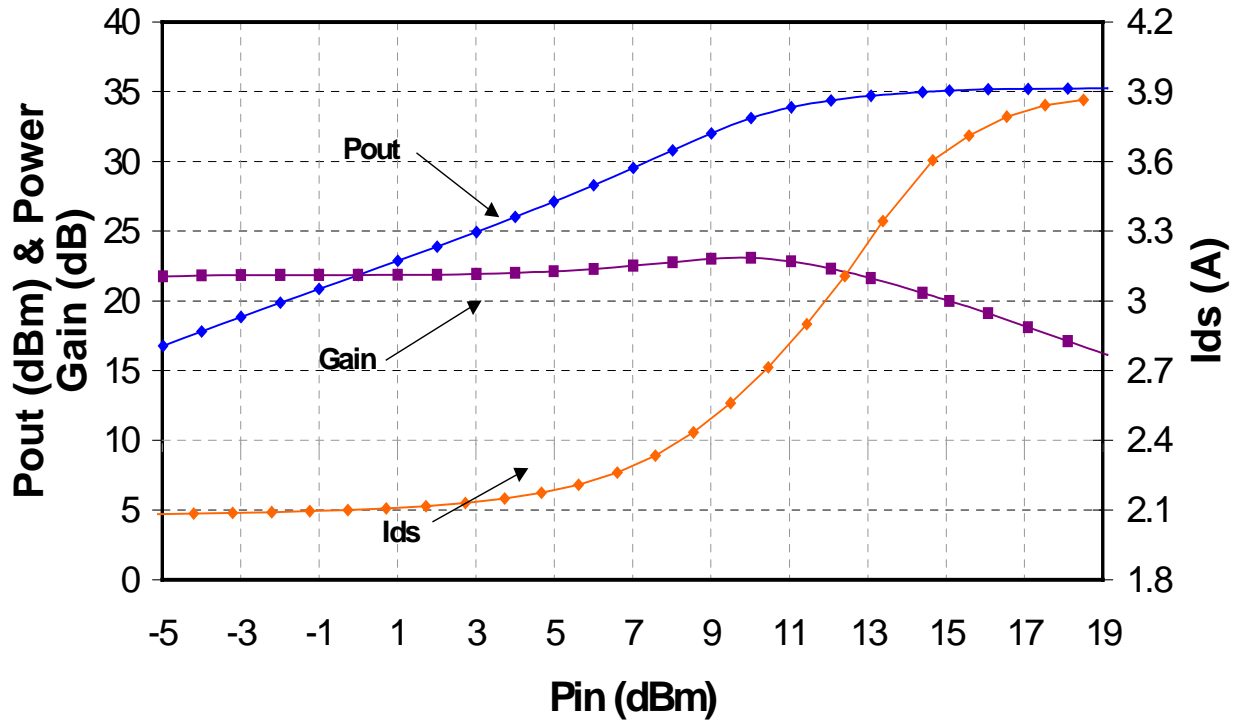

Package Pinout Diagram

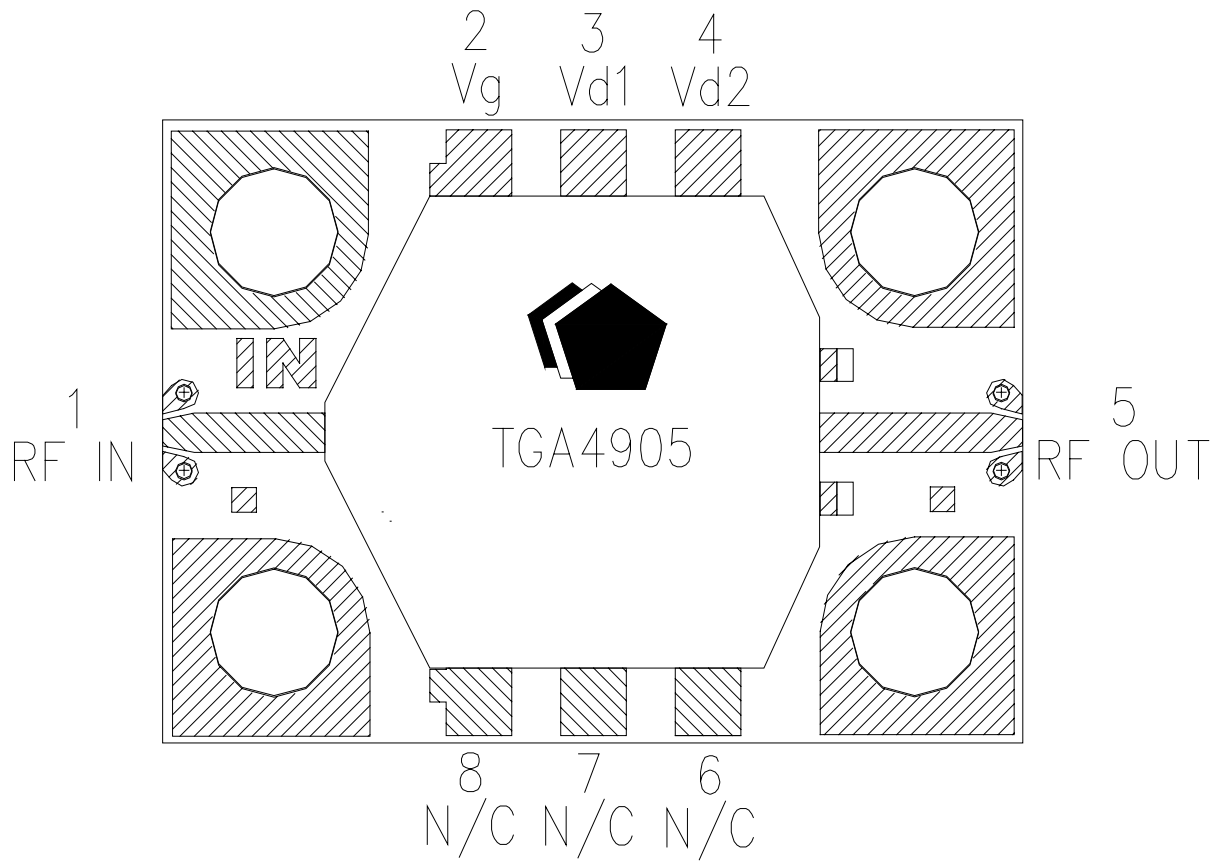

GaAs MMIC devices are susceptible to damage from Electrostatic Discharge. Proper precautions should be observed during handling, assembly and test.

Mechanical Drawing

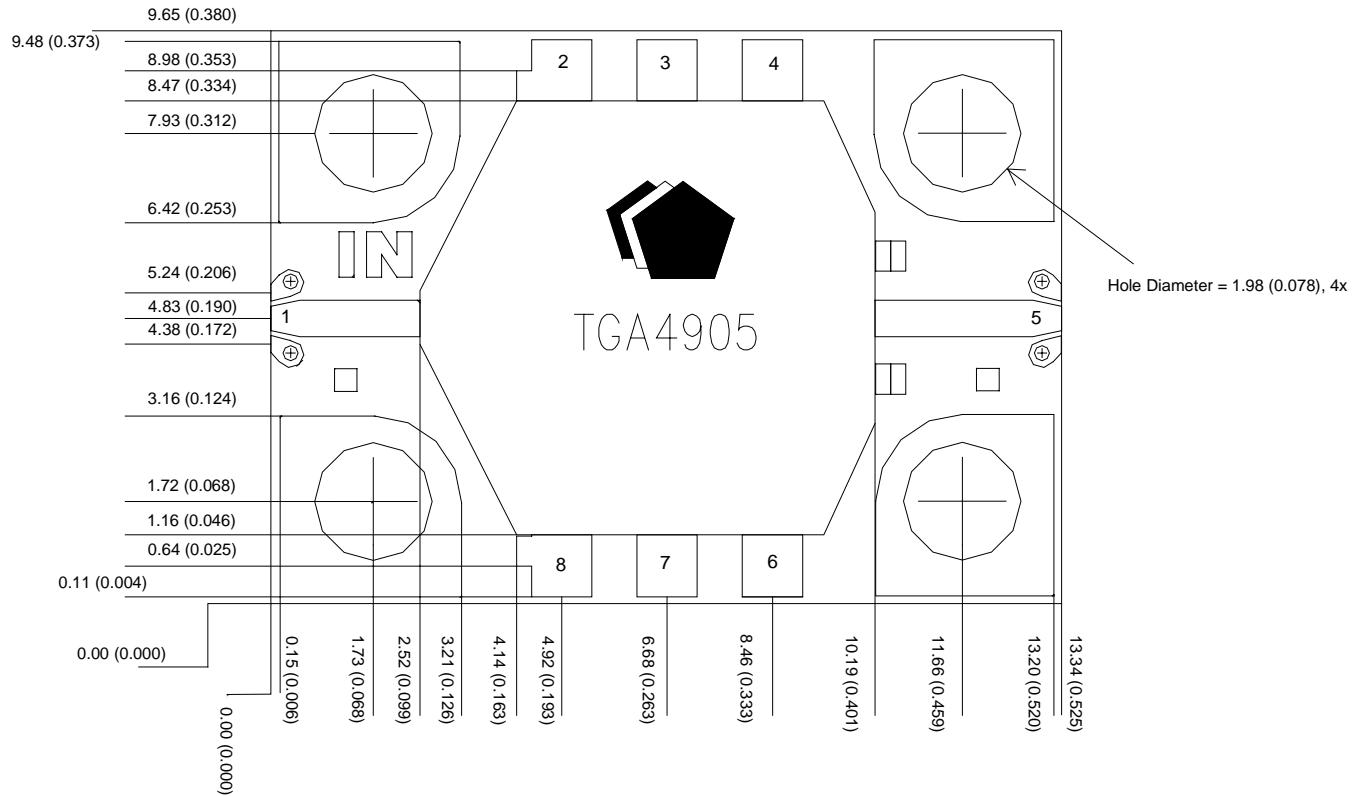

Units: millimeters (inches) Tolerance: +/-0.08 (0.003)
RF Ground through Backside

Bond Pad #1 (RF Input)	2.03 x 0.57	(0.080 x 0.022)
Bond Pad #2 (Vg)	1.02 x 1.03	(0.044 x 0.040)
Bond Pad #3 (Vd1)	1.02 x 1.03	(0.044 x 0.040)
Bond Pad #4 (Vd2)	1.02 x 1.03	(0.044 x 0.040)
Bond Pad #5 (RF Output)	2.66 x 0.61	(0.105 x 0.240)
Bond Pad #6 (N/C)	1.02 x 1.05	(0.044 x 0.041)
Bond Pad #7 (N/C)	1.02 x 1.05	(0.044 x 0.041)
Bond Pad #8 (N/C)	1.02 x 1.05	(0.044 x 0.041)

Top View

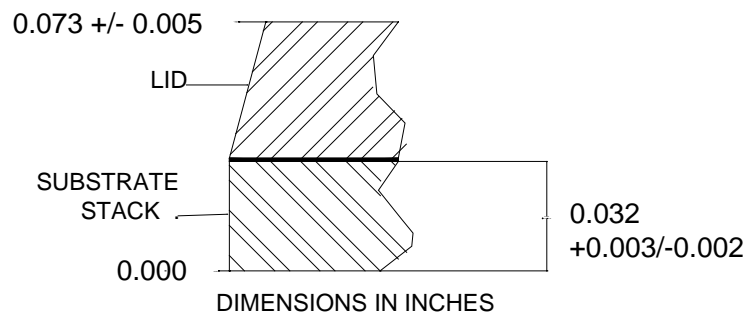

Side View

Bias Schematic

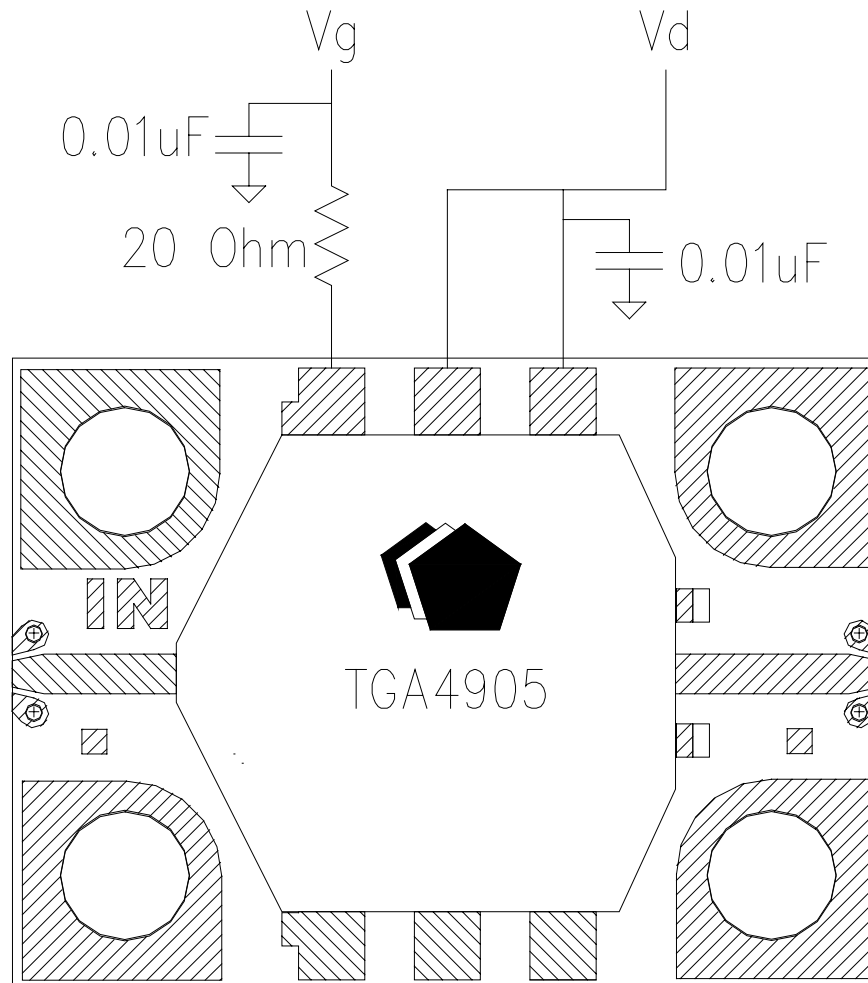

Two 1 mil wires are recommended for the RF Input, RF Output, Vg, and Vd1. Six bondwires are recommended for Vd2.

GaAs MMIC devices are susceptible to damage from Electrostatic Discharge. Proper precautions should be observed during handling, assembly and test.

Assembly of a TGA4905-CP into a Module

Manual Assembly for Prototypes

1. Clean the module with Acetone. Rinse with alcohol and DI water. Allow the module to fully dry.
2. To improve the thermal and RF performance, TriQuint recommends attaching a heatsink to the bottom of the package. If the TGA4905 is mounted to the heatsink with mounting screws, an indium shim or other compliant material should be inserted between the TGA4905 and the heatsink to reduce thermal contact resistance due to air gaps. The TGA4905 may also be mounted with DieMat DM6030HK conductive epoxy or an equivalent high thermal conductivity epoxy.
3. The DC and RF interconnects may be gold bondwires or gold ribbons. The RF interconnects should be as short as possible. A minimum of two 1 mil wires are recommended for the RF Input, RF Output, Vg, and Vd1. Six bondwires are recommended for Vd2.

ORDERING INFORMATION

PART	PACKAGE STYLE
TGA4905-CP	CARRIER PLATE